

# Energy Management Modular DC Energy analyzer Type VMU-E and VMU-X

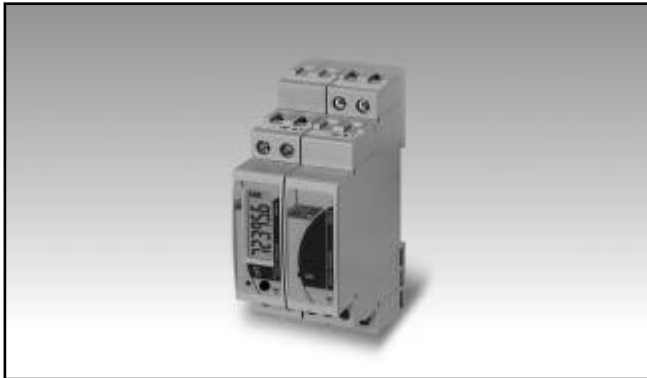

- Modular solution based on the combination of two units: VMU-E analysis unit and VMU-X universal power supply and RS485 communication unit.

## VMU-E, DC energy analysis unit



- Instantaneous variables: V, A, W
- Instantaneous variables data format: 4-DGTs
- Energy measurements: kWh
- Energies data format: 6 DGT
- Accuracy: class 1 (kWh),  $\pm 0.5$  RDG (current/voltage)
- Direct DC current measurement up to 20A
- External shunt DC current measurement up to 1000A
- Direct DC voltage measurement up to 400V
- Auxiliary power supply from VMU-X unit
- Dimensions: 1-DIN module
- Protection degree (front): IP40

## VMU-E Product Description

DC energy analyzer unit with built-in 6 digit display and programming push-button, particularly indicated for DC current, voltage, power and energy metering. Direct connection up to 20A and with external shunt up to 1000A. Moreover the unit is provided

with an auxiliary serial communication bus which is connected to the VMU-X unit so to provide an RS485 communication port. Housing for DIN-rail mounting, IP40 (front) protection degree.

## How to order **VMU-E AV00 XX X X**



## Type Selection

Range code	Power supply	Internal bus	Option
<b>AV00:</b> 400V DC - 20A (Direct connection) or external shunt input for currents up to 1000A (*)	<b>XX:</b> self-power supply from VMU-X unit	<b>X:</b> internal bus compatible only to VMU-X module (*)	<b>X:</b> none

(\*) as standard.

**VMU-X, universal power supply and RS485 communication unit or static digital output**

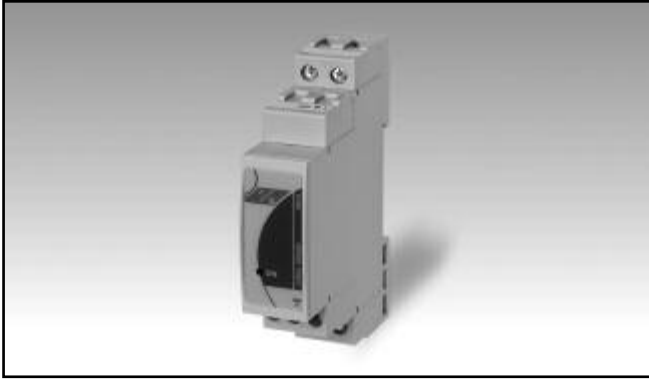

- Power supply module for VMU-E unit
- RS485 communication port (Modbus)
- One digital output for pulse retransmission proportional to the energy being measured or for alarm control
- 38 to 265 VAC/DC power supply input
- Dimensions: 1-DIN module
- Protection degree (front): IP40

**VMU-X Product Description**

Universal power supply module suitable to be used in combination to VMU-E unit. In order to improve the communication capability of VMU-E unit, VMU-X can be provided with either an RS485 communication port or with a static output. Housing for DIN-rail mounting, IP40 (front) protection degree.

**How to order**

**VMU-X U S1 X**

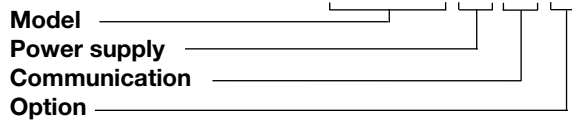

**Type Selection**

Power supply	Communication	Option	(*) as standard.
<b>U:</b> from 38 to 265VAC/DC (*)	<b>S1:</b> RS485 Modbus (*) <b>D1:</b> static digital output for pulse retransmission or alarm control (*)	<b>X:</b> none	

## VMU-E Display and LED specifications

<b>Display</b> Type Information read-out	1 line (max: 6-DGT) LCD, h 7mm From 4 to 6-DGT depending on the information.	priority on any other condition: energy consumption or communication). Green blinking light: the communication on the RS485 bus is working. Note: in case of energy counting or communication condition, the LED alternates its colour from red to green.
<b>LED</b> Type Status and colour	Dual colour Red blinking light: energy consumption; 1000 pulses/kWh (Max Frequency 16 Hz). Red steady light: alarm detected (it has the	

## VMU-X LED specification

<b>LED</b> Type	Single colour	Colour	Green: the power supply is ON.
--------------------	---------------	--------	--------------------------------

## VMU-E input specifications

<b>Rated inputs</b> Current input Current direct conn. range Current external shunt conn. range Voltage range	1 (internal shunt) From 0 to 20A DC From 0 to 120mV DC From 0 to 400V DC	<b>Max. and Min. indication</b>	See "VMU-E set of variables"
<b>Accuracy</b> Current direct conn. range Start up current Current external shunt conn. Start up current Voltage Start up voltage Power Energy	(@25°C ±5°C, R.H. ≤60%) ±(0.5%RDG+2 DGT) from 0.05A to 20A DC 50mA DC ±(0.5%RDG+2 DGT) from 0.1mV to 120mV DC 0.1mV DC ±(0.5%RDG+2 DGT) from 10V to 400V DC 10V DC ±(1% RDG+ 2DGT) ±(1% RDG)	<b>Input impedance</b> Voltage Current direct connection Current external shunt conn.	= 5MΩ < 0.006Ω+ @ 0.5 Nm (screw terminal torque). > 30kΩ
<b>Temperature drift</b>	≤200ppm/°C	<b>Voltage Overloads</b> Continuous For 1s	500V 800V
<b>Measurement sampling time</b>	≤150 sec	<b>Current Overloads</b> Direct connection Continuous For 1s External shunt connection Continuous For 1s	20A DC 100A DC max 10V DC 20V DC max
<b>Key-pad</b>	1 push-button for variable scrolling and programming of the instrument working parameters.		
<b>Display read-out</b> Instantaneous variables Resolution Energy	4-DGT (V, A, W) 0.1V; 0.01A; 0.01kW (for more details see "VMU-E set of variables") Total: 6-DGT (0.1KWh)		



## VMU-X Output specifications

<p><b>RS485</b></p> <p>Type</p> <p>Connections</p> <p>Addresses</p> <p>Protocol</p> <p>Data (bidirectional)</p> <p>    Dynamic (reading only)</p> <p>    Static (writing only)</p> <p>Data format</p> <p>Baud-rate</p> <p>Driver input capability</p> <p>Special functions</p> <p>Insulation</p>	<p>Multidrop, bidirectional (static and dynamic variables)</p> <p>2-wire. Max. distance 1000m</p> <p>247, selectable by means of the front push-button MODBUS/JBUS (RTU)</p> <p>All variables, see table "List of the variables that can be displayed and connected to ..."</p> <p>All the configuration parameters.</p> <p>1 start bit, 8 data bit, no parity, 1 stop bit</p> <p>Selectable: 9600, 19200, 38400, 115200 bits/s</p> <p>Parity: none</p> <p>1/5 unit load. Maximum 160 transceivers on the same bus.</p> <p>None</p> <p>See the table "Insulation between inputs and outputs"</p>	<p>Type</p> <p>Load</p> <p>Pulse output</p> <p>    Pulse duration</p> <p>Alarm output</p> <p>    Operating mode</p> <p>Alarm modes</p> <p>    Controlled variables</p> <p>Set-point adjustment</p> <p>Hysteresis</p> <p>On-time delay</p> <p>Off-time delay</p> <p>Min. response time</p> <p>Insulation</p>	<p>Static: opto-mosfet;  <math>V_{ON}</math> 2.5 VAC/DC max. 70 mA,  <math>V_{OFF}</math> 260 VAC/DC max.</p> <p><math>\geq 100ms &lt; 120msec</math> (ON),  <math>\geq 120ms</math> (OFF)</p> <p>With digital output: real alarm; with RS485: virtual alarm.</p> <p>Up alarm or down alarm  W, V, A (see the table "List of the variables that can be displayed and connected to ...")</p> <p>Programmable on all the measuring range (see "VMU-E set of variables")</p> <p>Programmable on all the measuring range (see "VMU-E set of variables")</p> <p>0 to 9999s (166min)  0 to 9999s (166min)  <math>\leq 1s</math>, set-point on-time delay: "0 s"</p> <p>See the table "Insulation between inputs and outputs"</p>
<p><b>Digital output</b></p> <p>Number of outputs</p> <p>Purpose</p>	<p>1</p> <p>Selectable either for pulse transmission proportional to the energy being measured or for alarm control on selected variable.</p>		



## Main functions

<b>Displaying</b>	1 variable per page. See ("VMU-E set of variables")	<b>Scaling of external shunt current input</b> Input scale  Display scale	Programmable from 0 to 120mV DC Programmable from 0 to 1000A DC
<b>Password</b>	Numeric code of max. 4 digits; 2 protection levels of the programming data: Password "0", no protection; Password from 1 to 9999, all data are protected		
1st level 2nd level			
<b>Energy reset</b>	By means of the front push-button		

## Insulation between inputs and outputs

Module	Type of input/output	VMU-E	VMU-X		
		Measuring input	Power Supply	RS485 port	Static output
<b>VMU-E</b>	Measuring input	-	4kV	4kV	4kV
<b>VMU-X</b>	Power Supply	4kV	-	4kV	4kV
	RS485 port	4kV	4kV	-	4kV
	Static output	4kV	4kV	4kV	-



## General specifications

<b>Operating temperature</b>	-25 to +55°C (-13°F to 131°F) (R.H. from 0 to 90% non-condensing @ 40°C)	Immunity to conducted disturbances	EN61000-4-6: 10V from 150KHz to 80MHz; EN61000-4-5: 2kV on power supply; 4kV on current inputs.
<b>Storage temperature</b>	-30 to +70°C (-22°F to 158°F) (R.H. < 90% non-condensing @ 40°C)	Surge	
<b>Installation category</b>	Cat. III (IEC 60664, EN60664)	<b>EMC (Emission)</b> Radio frequency suppression	According to EN61000-6-3 According to CISPR 22
<b>Insulation (for 1 minute)</b>	See table "Insulation between inputs and outputs"	<b>Standard compliance</b> Safety	IEC60664, IEC61010-1 EN60664, EN61010-1
<b>Dielectric strength</b>	4000 VAC RMS for 1 minute	<b>Approvals</b>	CE
<b>Noise rejection</b> CMRR	>65 dB, 45 to 65 Hz	<b>Housing</b> Dimensions (WxHxD) Material	17.5 x 90 x 67 mm Noryl, self-extinguishing: UL 94 V-0
<b>EMC (Immunity)</b> Electrostatic discharges	According to EN61000-6-2 EN61000-4-2: 8kV air discharge, 4kV contact;	<b>Mounting</b>	DIN-rail
Immunity to irradiated Electromagnetic fields	EN61000-4-3: 10V/m from 80 to 3000MHz; EN61000-4-4: 4kV on power lines, 2kV on single lines;	<b>Protection degree</b> Front Screw terminals	IP40 IP20
Immunity to Burst			

## VMU-E connections

<b>Connections</b> Cable cross-section area Current, voltage	Screw-type  Min. 2.5 mm <sup>2</sup> , max 6 mm <sup>2</sup> in case of flexible wire, Max. 10 mm <sup>2</sup> in case of rigid wire. Min./Max. screws tightening torque: 0.5 Nm / 1.1 Nm Max 1.5 mm <sup>2</sup> , Min./Max. screws tightening torque: 0.4 Nm / 0.8 Nm	<b>Screw terminal purposes</b> 6/10 mm <sup>2</sup>  1.5 mm <sup>2</sup>	4 screw terminals: 1 (+) for current input, 1 (+) for current output 2 (+) external shunt input 2 screw terminals: for negative connection
Current shunt		<b>Weight</b>	

## VMU-X connections

<b>Connections</b> Cable cross-section area	Screw-type 1.5 mm <sup>2</sup> max. Min./Max. screws tightening torque: 0.4 Nm / 0.8 Nm		nals used for static output, 2 screw terminals used for power supply
<b>Screw terminal purposes</b> 1.5 mm <sup>2</sup>	3 screw terminals used for RS485 port. 2 screw termi-	<b>Weight</b>	Approx. 100 g (packing included)

## VMU-E power supply specifications

Power supply

Self-power supplied

through the VMU-X unit

## VMU-X power supply specifications

Power supply

38 to 265 VAC/DC

Power consumption

1.5W, 3VA (VMU-X + VMU-E)

## VMU-E set of variables

No.	Variables	Display read-out	Notes
1	V	0.0 to 999.9	
2	A	0.0 to 20.00	In case of external shunt input: 0.0 to 999.9
3	kW	0.0 to 99.99	In case of external shunt input: 0.0 to 999.9
4	kWh	0.0 to 99999.9	In case of external shunt input: 0.0 to 999999

## List of the variables that can be displayed and connected to ...

- RS485 communication port
- Alarms

No	Variable	Display	RS485	Alarm	Reset	Notes
1	V	Yes	Yes	Yes	No	
2	V min	No	Yes	No	Yes	The value is saved into E <sup>2</sup> PROM
3	V max	No	Yes	No	Yes	The value is saved into E <sup>2</sup> PROM
4	A	Yes	Yes	Yes	No	
5	A min	No	Yes	No	Yes	The value is saved into E <sup>2</sup> PROM
6	A max	No	Yes	No	Yes	The value is saved into E <sup>2</sup> PROM
7	kW	Yes	Yes	Yes	No	
8	kW min	No	Yes	No	Yes	The value is saved into E <sup>2</sup> PROM
9	kW max	No	Yes	No	Yes	The value is saved into E <sup>2</sup> PROM
10	kWh	Yes	Yes	No	Yes	The value is saved into E <sup>2</sup> PROM
11	Alarm	No	Yes	Yes	No	There is only one alarm which can be linked to the available instantaneous variables

## VMU-E connections

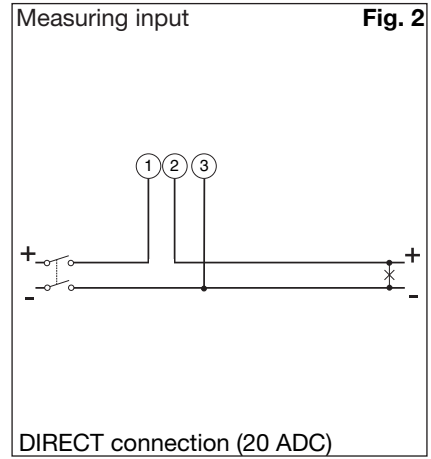
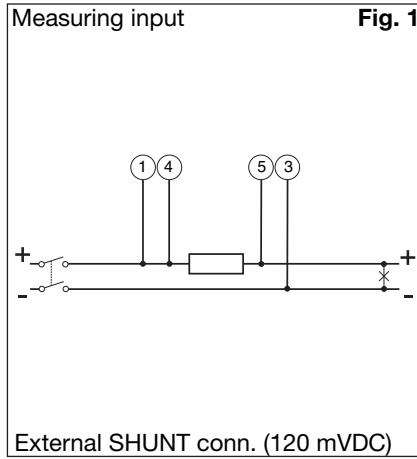
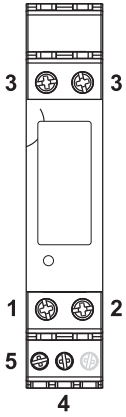

## VMU-X connections

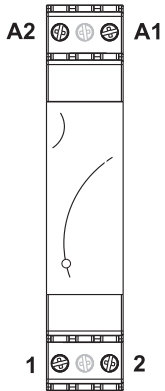

VMU-X D1

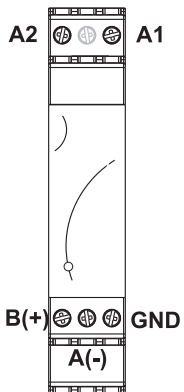
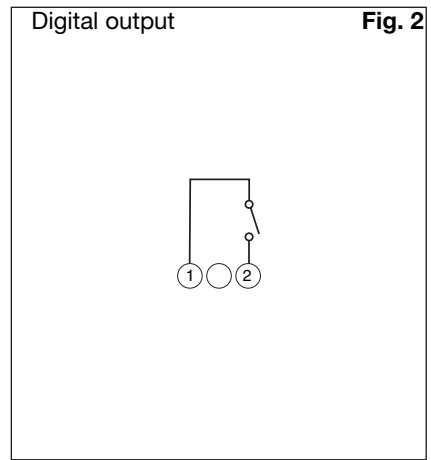
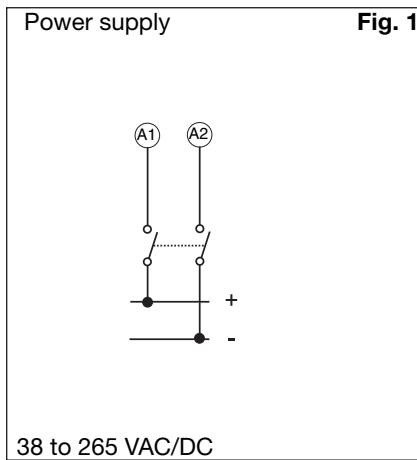

VMU-X S1

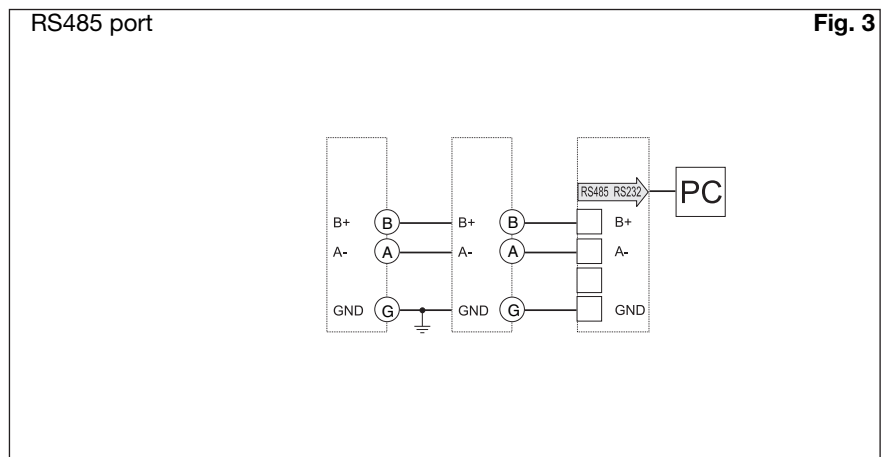



## VMU-E Frontal panel description

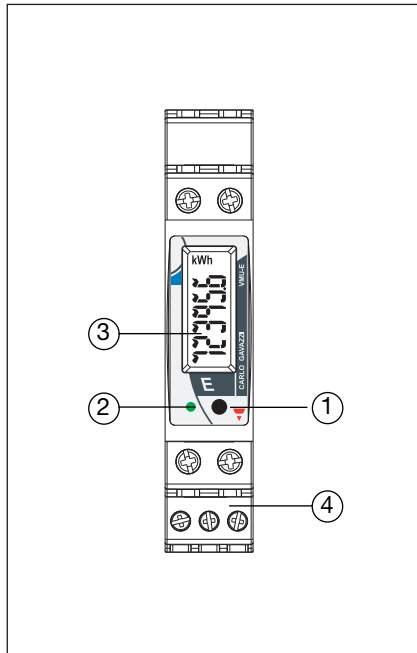

**1. Push button.**

To program the configuration parameters and to scroll the variables. One key function: short time pushbutton click: variable scroll or parameter increasing. Long time pushbutton click: programming procedure entering, parameter selection confirmation.

**2. LED.**

Red blinking light: energy consumption; 1000 pulses/kWh (Max Frequency 16 Hz). Red steady light: alarm detected (it has the priority on any other condition: energy consumption or communication). Green blinking light: the communication on the RS485 bus is working. Note: in case of energy counting or communication condition, the LED alternates its colour from red to green.

**3. Display.**

LCD-type with alphanumeric indications to:

- display the configuration parameters;
- display some measured variables.

**4. Screw terminals.**

For measuring input connections.

## VMU-X Frontal panel description

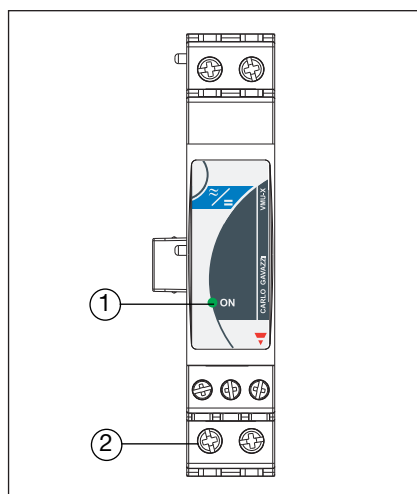

**1. LED**

Green: the power supply is ON.

**2. Screw terminals**

For power supply and either digital output or communication port connections.

## VMU-E Dimensions and panel cut-out

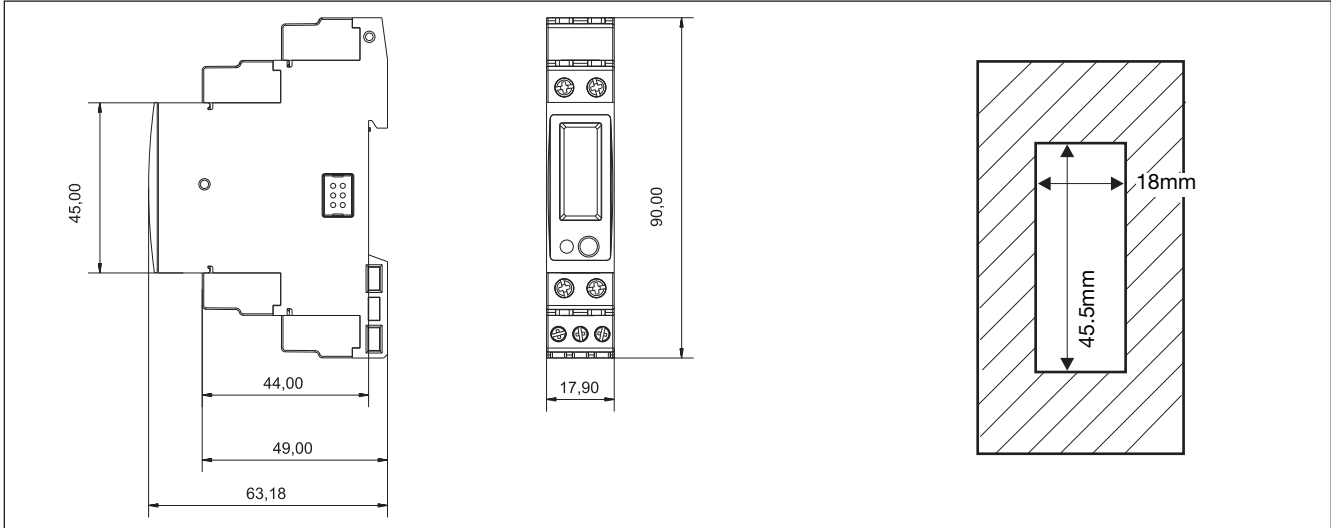

## VMU-X Dimensions and panel cut-out

